

RELACÃO DO AÇO

ACO	N	DIAM (mm)	QUANT	C UNIT (cm)	C TOTAL (cm)
CA50	2	5.0	685	11	76935
	3	5.0	221	22	520
	4	5.0	2	255	510
	6	5.0	2	255	510
	6	5.0	2	744	1488
	7	5.0	2	515	1030
	9	5.0	2	232	464
	9	5.0	2	279	558
	10	5.0	2	232	464
	11	5.0	2	638	1276
	13	5.0	2	270	540
	14	6.3	6	1175	7050
	16	8.0	4	1888	4352
	17	8.0	4	1888	4352
	18	8.0	2	944	1888
	18	8.0	2	944	1888
	20	8.0	2	1120	2240
	21	8.0	2	242	484
	21	8.0	2	242	484
	22	8.0	2	242	484
	23	8.0	2	242	484
	24	8.0	2	340	680
	25	8.0	2	132	264
	26	8.0	2	132	264
	27	8.0	2	320	640
	28	8.0	2	320	640
	30	8.0	2	335	670
	31	8.0	2	166	332
	31	8.0	2	166	332
	33	8.0	2	157	314
	34	8.0	9	97	873
	35	8.0	1	227	454
	35	8.0	1	227	454
	37	8.0	1	205	410
	38	8.0	2	105	210
	39	8.0	2	783	1566
	40	8.0	2	783	1566
	41	8.0	2	117	234
	41	8.0	2	117	234
	43	8.0	1	180	360
	43	8.0	1	180	360
	44	8.0	3	677	2031
	45	8.0	3	677	2031
	47	8.0	1	224	448
	48	8.0	4	538	2152
	48	8.0	4	538	2152
	50	8.0	1	155	310
	51	8.0	2	375	750
	51	8.0	2	375	750
	52	8.0	2	481	962
	52	8.0	2	481	962
	54	8.0	2	813	1626
	55	8.0	2	146	292
	55	8.0	2	146	292
	58	8.0	2	64	128
	58	8.0	2	64	128
	60	10.0	2	594	1188
	60	10.0	2	594	1188
	61	10.0	1	385	770
	62	10.0	2	1120	2240
	64	10.0	1	165	330
	65	10.0	1	225	450
	67	12.5	2	193	386
	67	12.5	2	193	386
	68	12.5	2	790	1580

RESUMO DO AÇO

ACO	DIAM (mm)	C TOTAL (m)	PESO + 10% (kg)
CA50	6.3	70.5	19
	10.0	38.6	58
	12.5	18.8	58.9
CA60	16.0	15.8	27.4
PESO TOTAL	3.0	857.1	145.3
CA50		282.2	
CA60		145.3	

Volume de concreto (C-30) = 9.49 m³  
 Área de forma = 116.62 m²

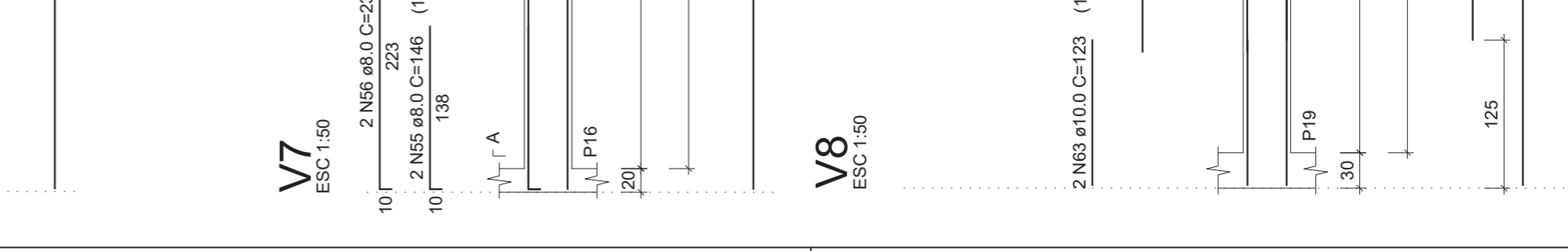
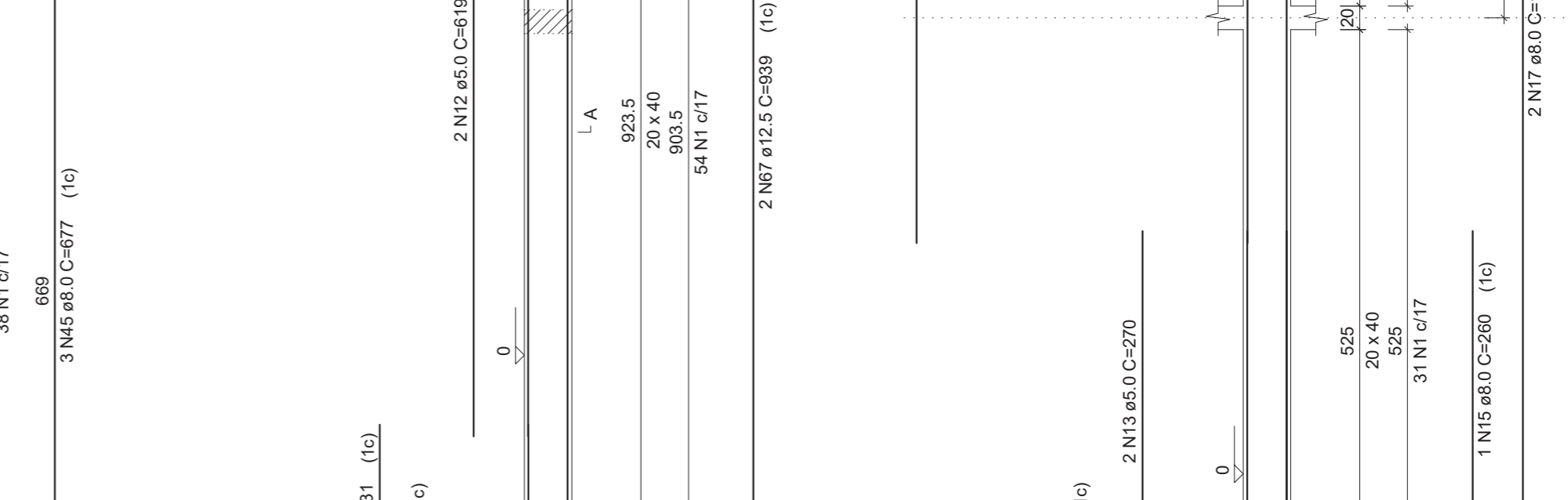
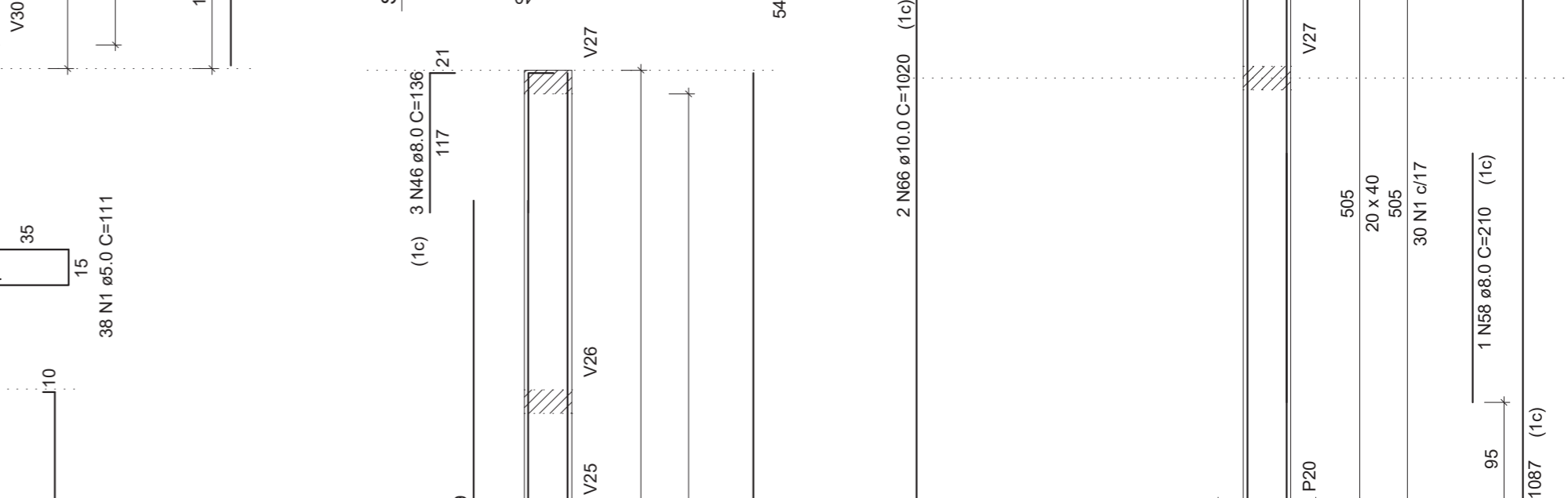
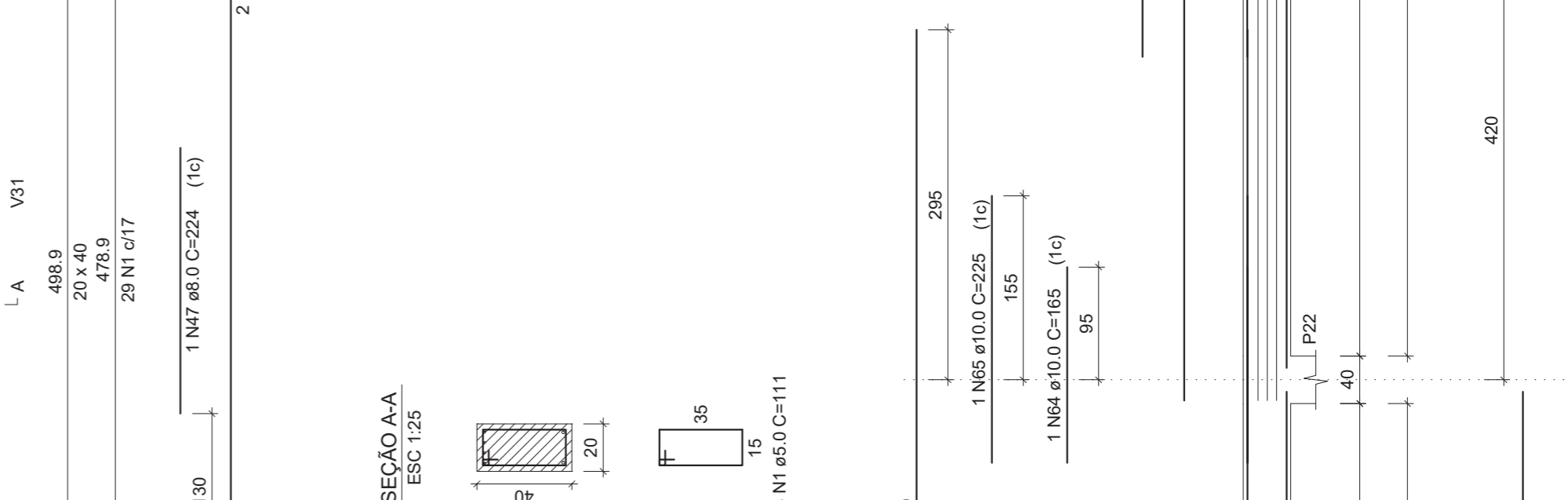
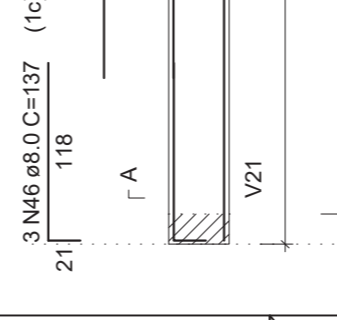
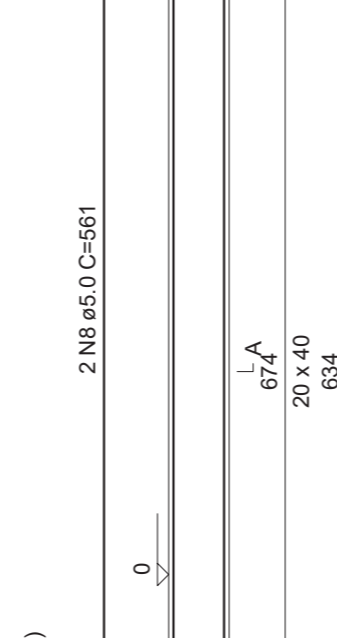
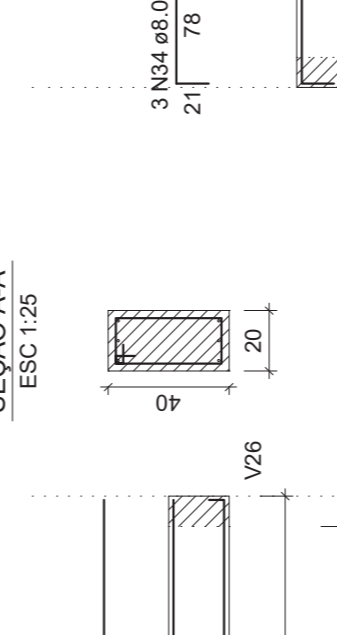
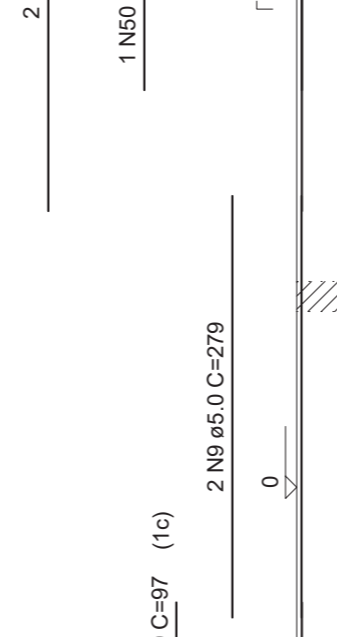
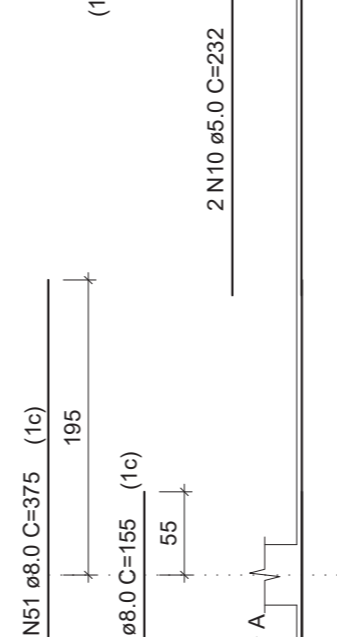
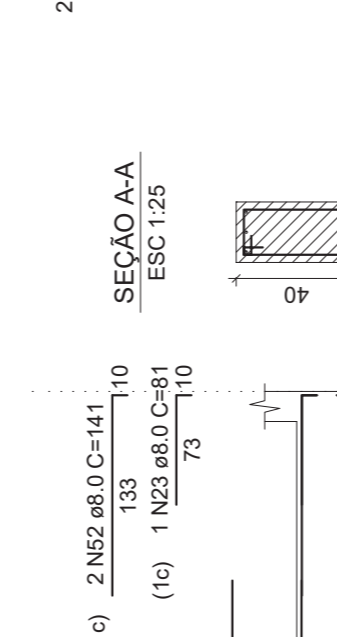
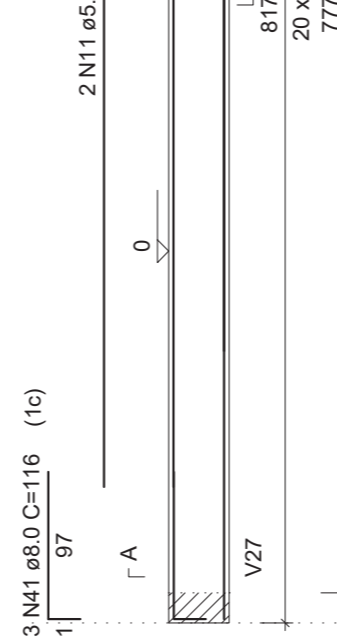
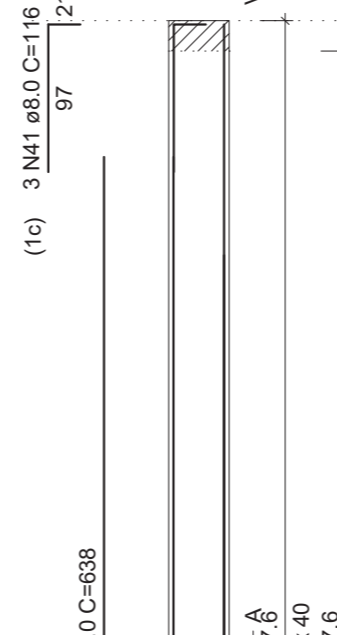
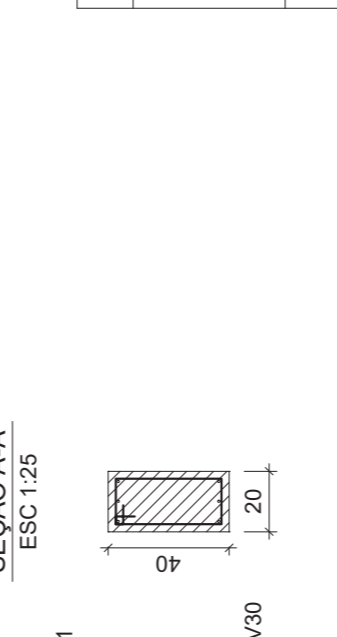
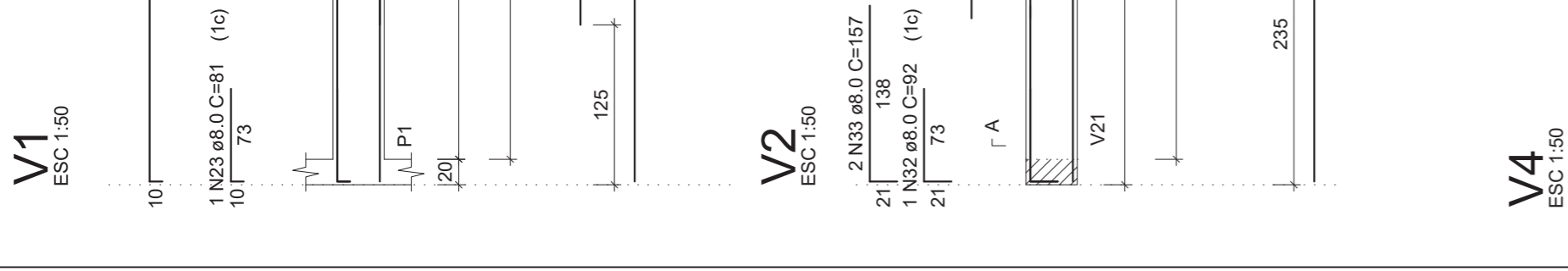
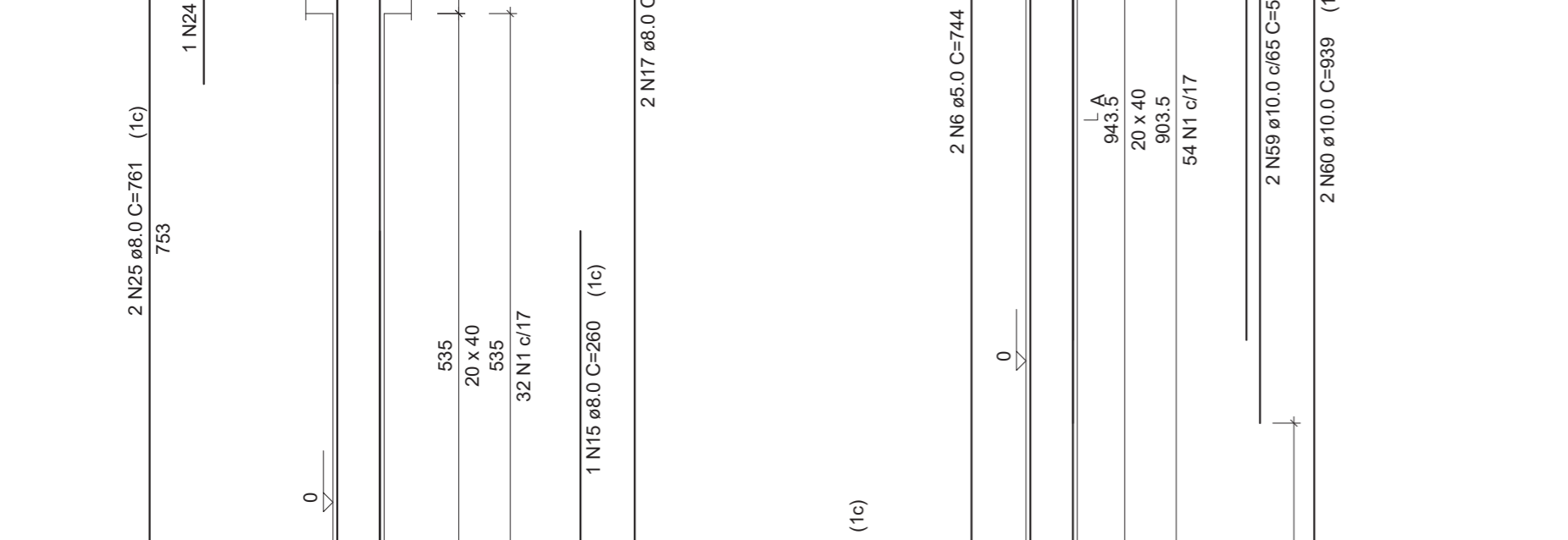
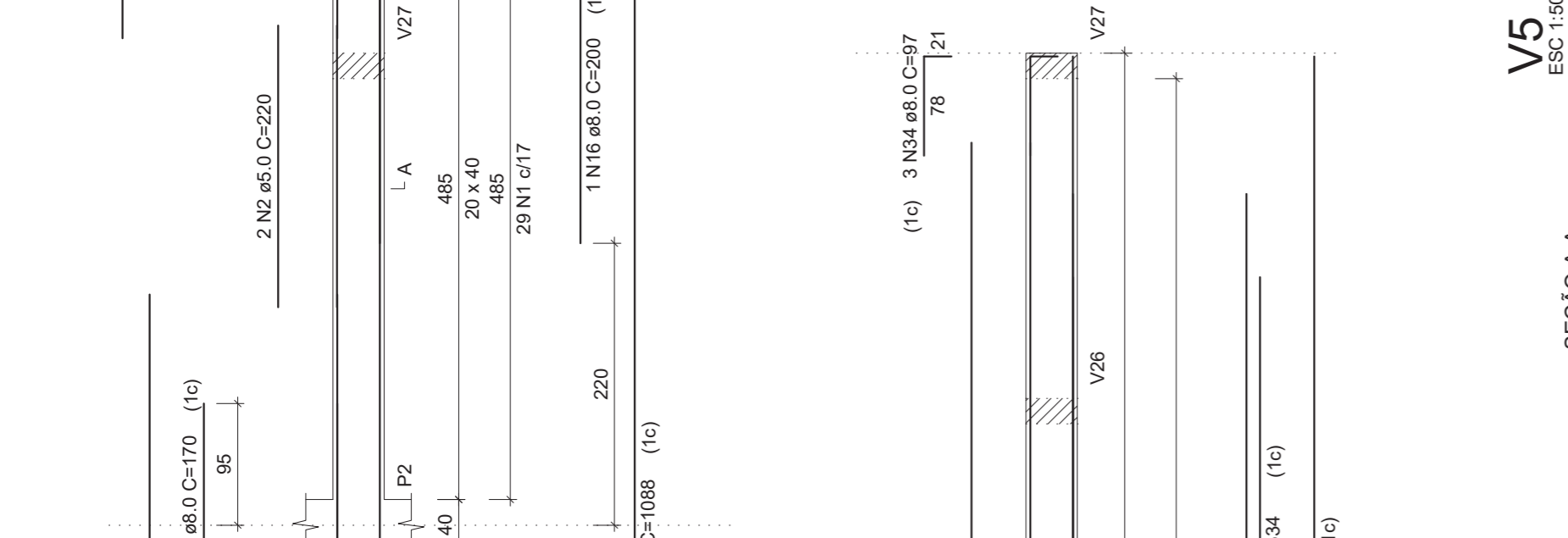
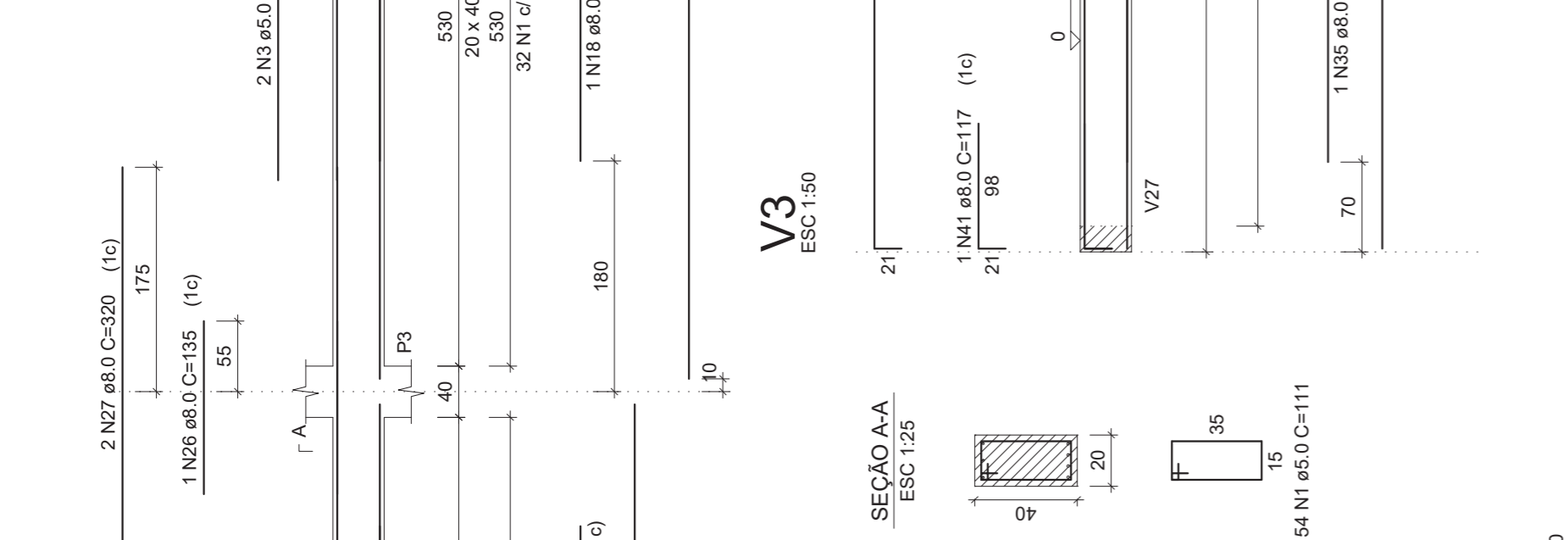
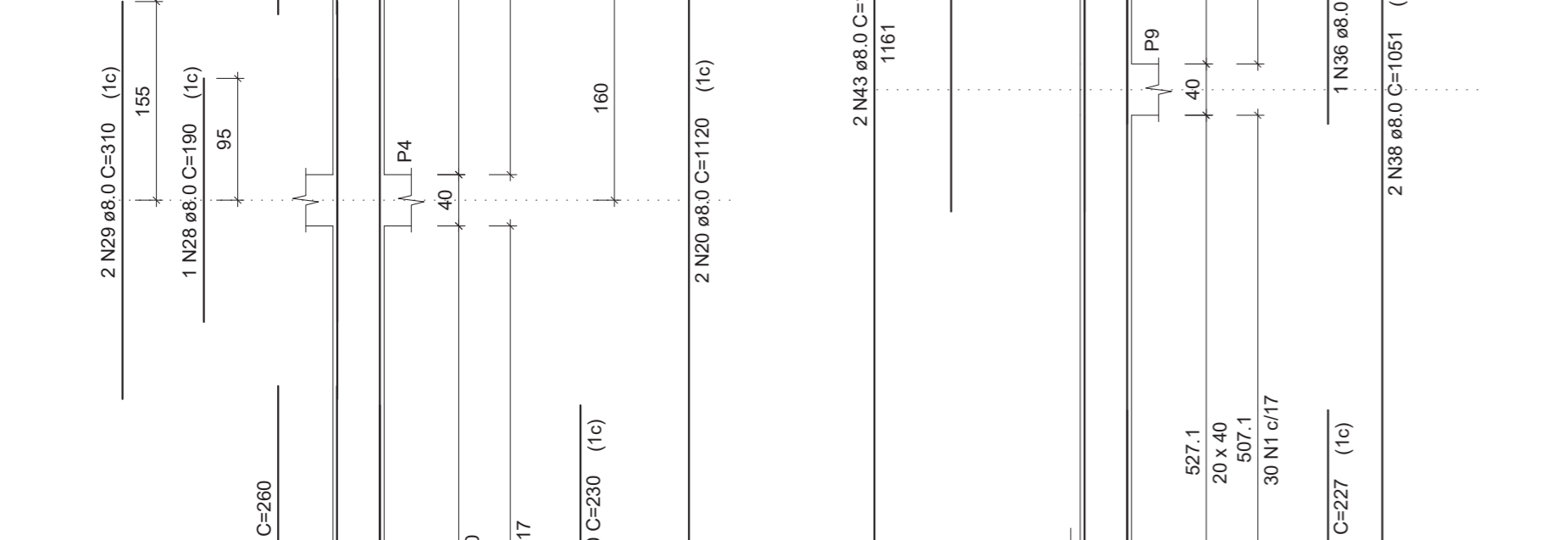
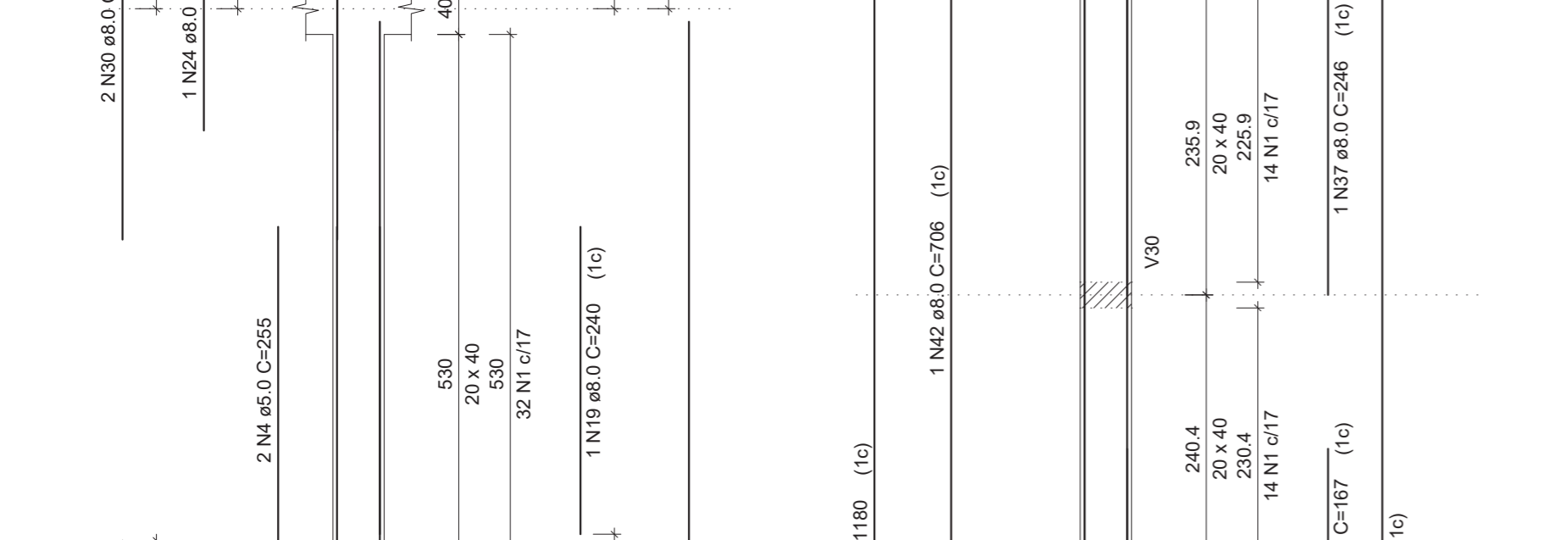
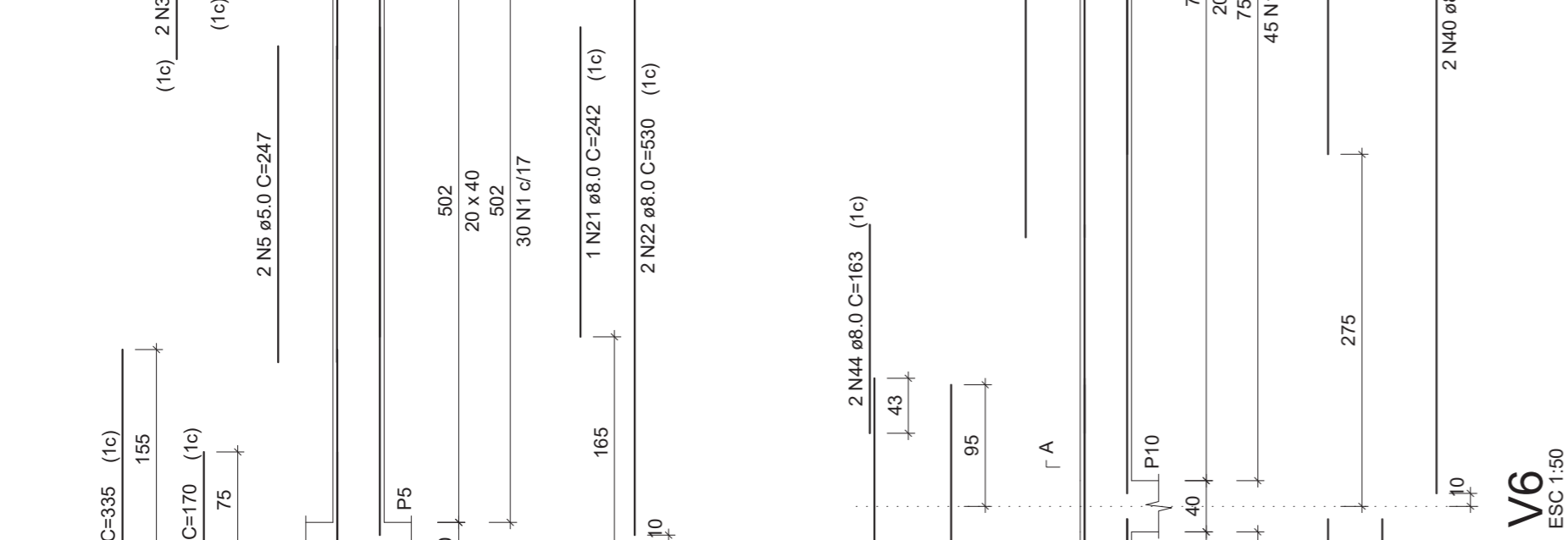
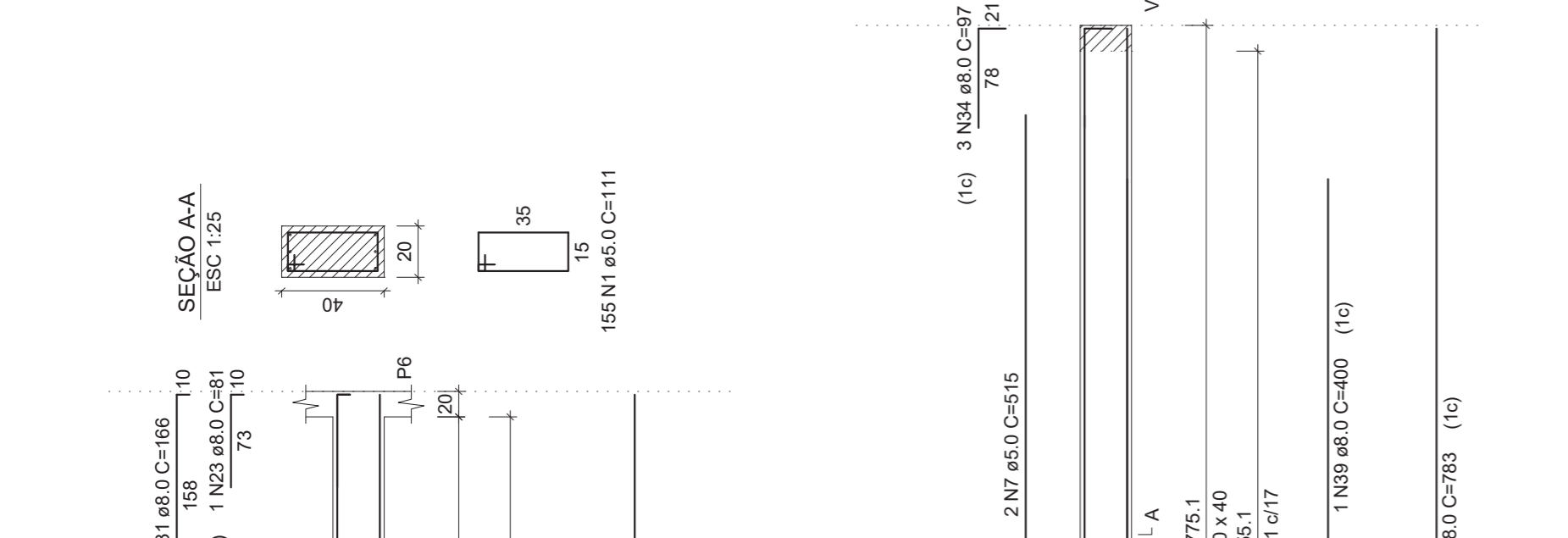
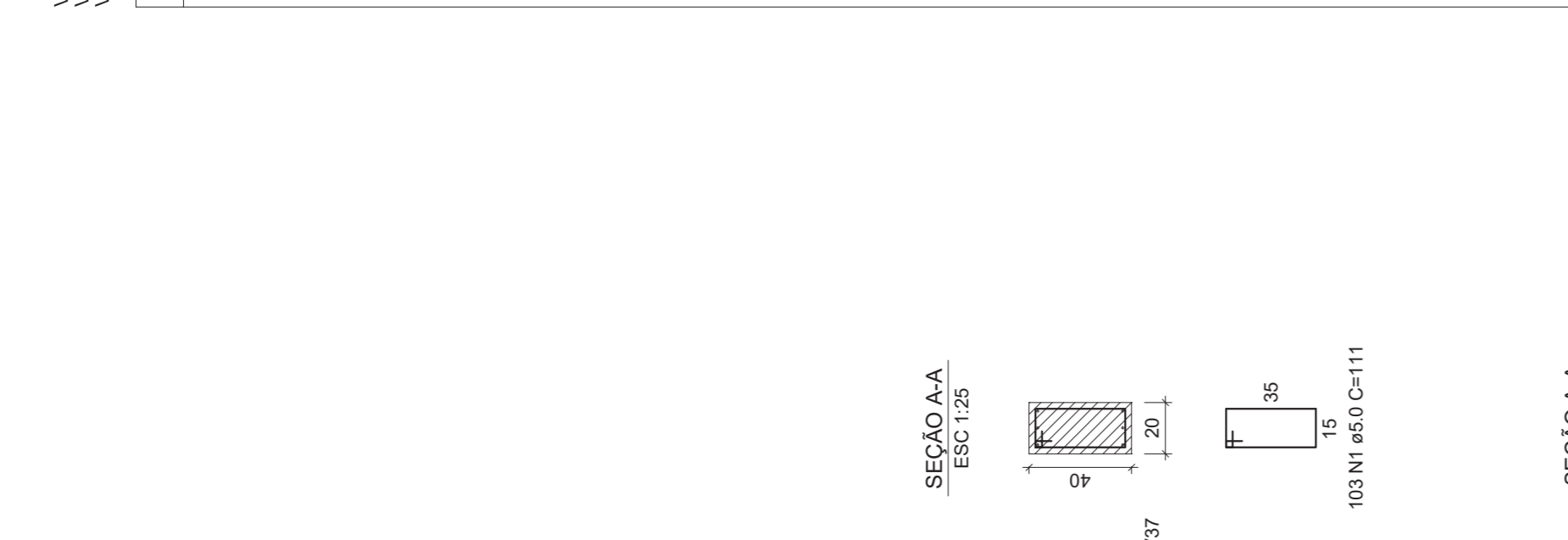

**PROJETO ESTRUTURAL**

**CENTRO DE EVENTOS**

**PAVIMENTO BALDRAME**

**VIGAS**

Gustavo Ribeiro da Silva  
 CREA/RN 208/184  
 54-9.81390048

Escala: 1/50  
 Desenho: 01  
 Data: 14/09/18  
 Unidade: cm

DESENHO: 01  
 FOLHA: 01/05